

UNIVERSIDAD NACIONAL AUTÓNOMA DE MÉXICO
FACULTAD DE ESTUDIOS SUPERIORES CUAUTITLÁN

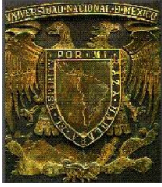

DEPARTAMENTO DE INGENIERÍA



LABORATORIO DE TECNOLOGÍA DE MATERIALES

LECTURAS DE INGENIERÍA 12 (Rev. 1)

**DIAGRAMAS PARA INGENIERÍA DE
MATERIALES**



M. en I. Felipe Díaz del Castillo Rodríguez.



Figura 1.- Diagrama de fases Fe- Fe₃C



Figura 2. Zona hipoeutectoide

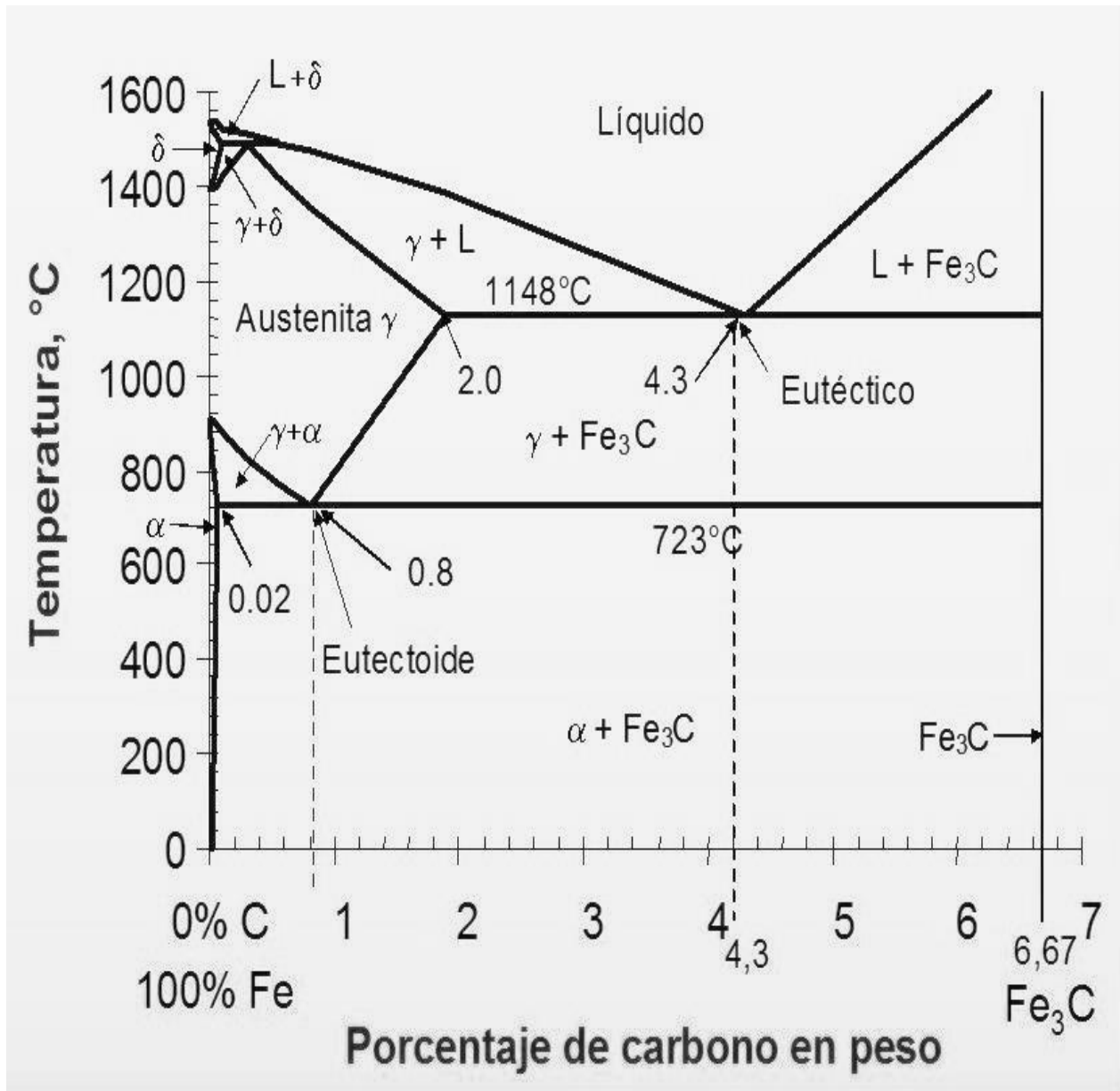

Figura 3. La zona δ

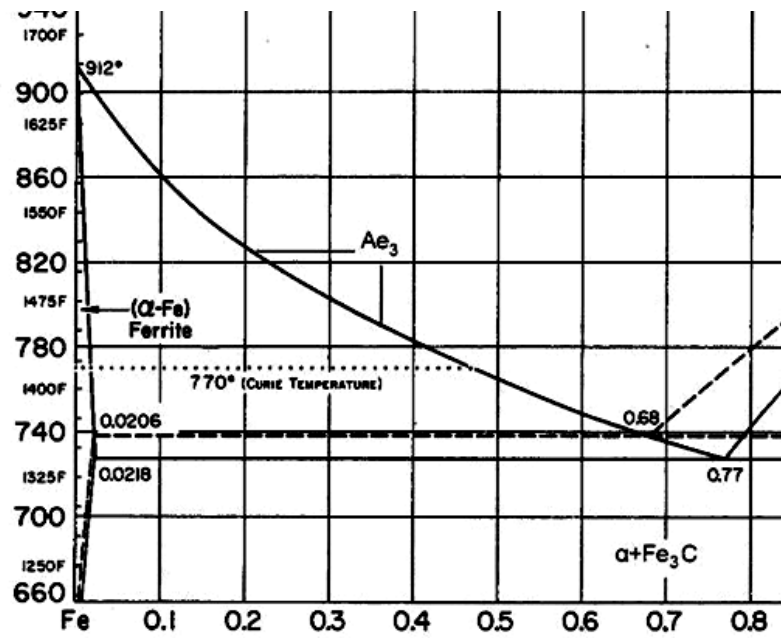

a) Hierro fundido gris (sin ataque químico)

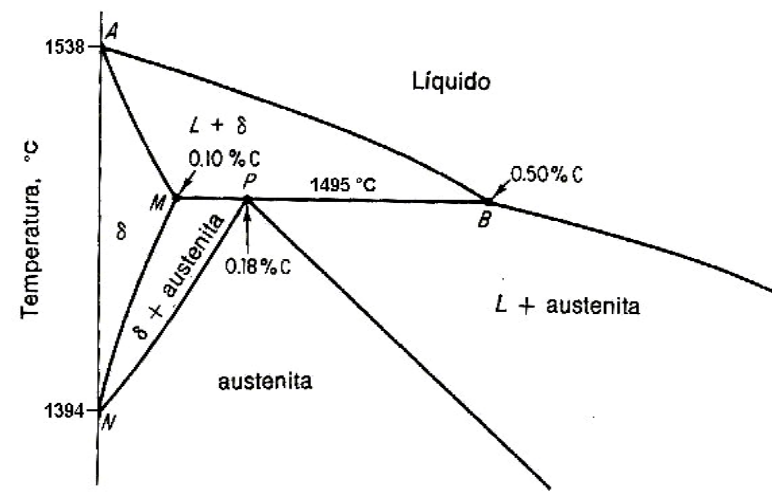
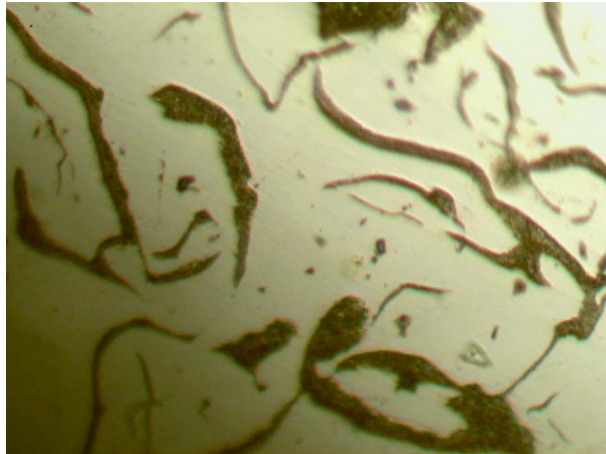
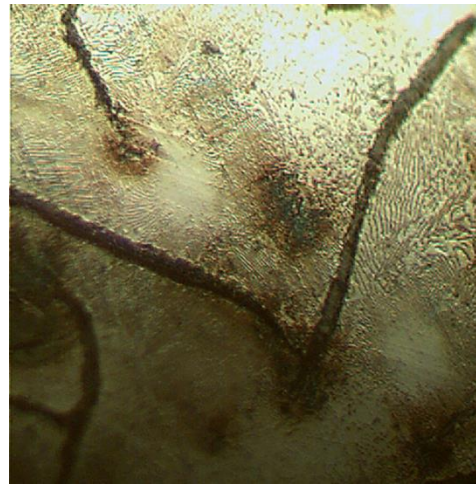

b) Hierro fundido gris, atacado con nital al 2%

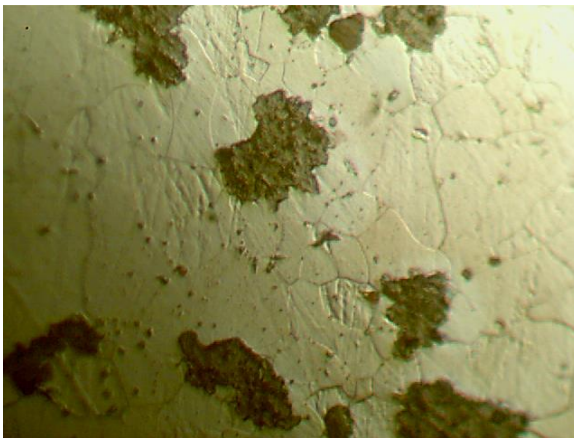

c) Hierro fundido maleable, matriz ferrítica.

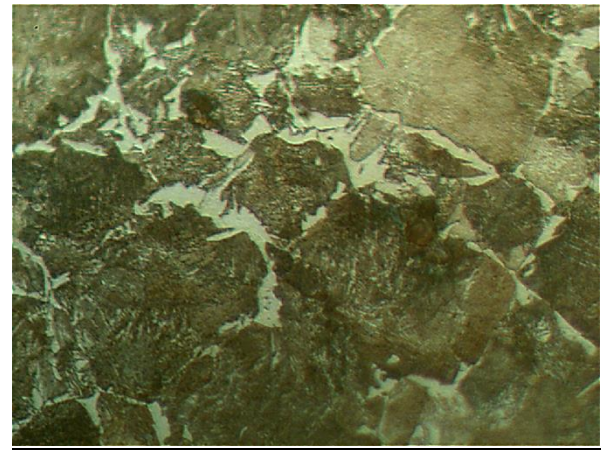

d) Acero hipoeutectoide (varilla para construcción)

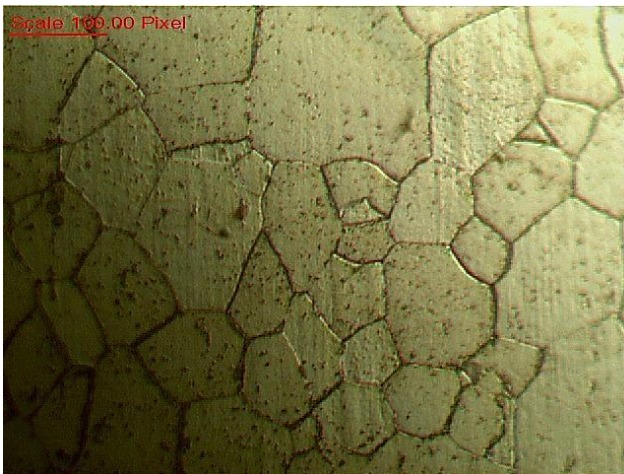

e) Alambre de acero recocido (400X)

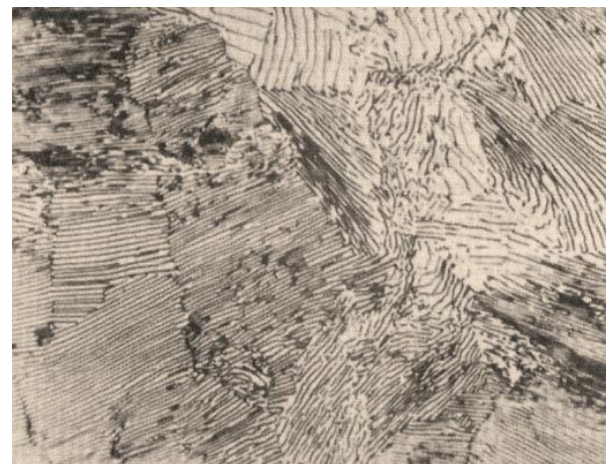

f) Acero eutectoide (100% perlita)

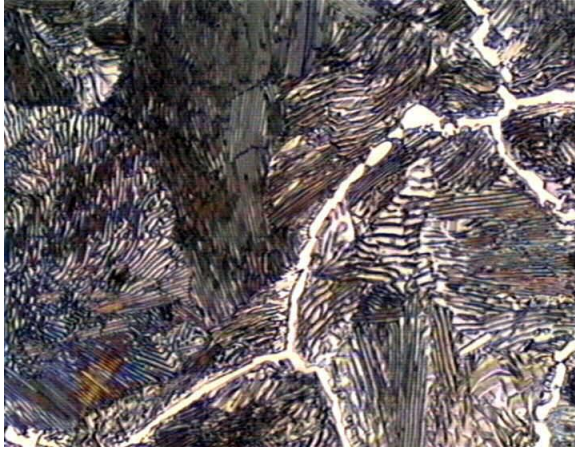

g) Acero hipereutectoide (1.2% C)

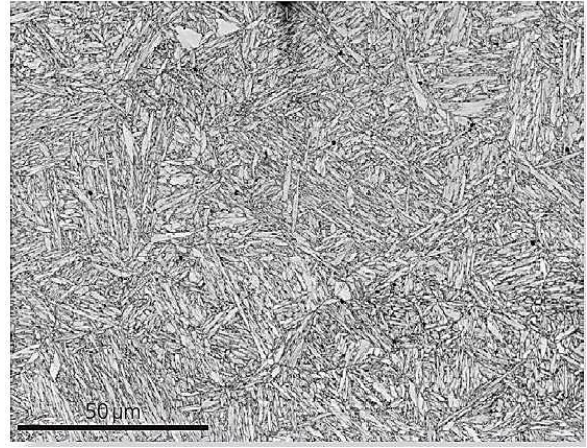

h) Martensita

Figura 4. Microestructuras del acero



Figura 5.- Diagrama de fases aluminio-cobre



Figura 6.- Diagrama de fases aluminio-silicio

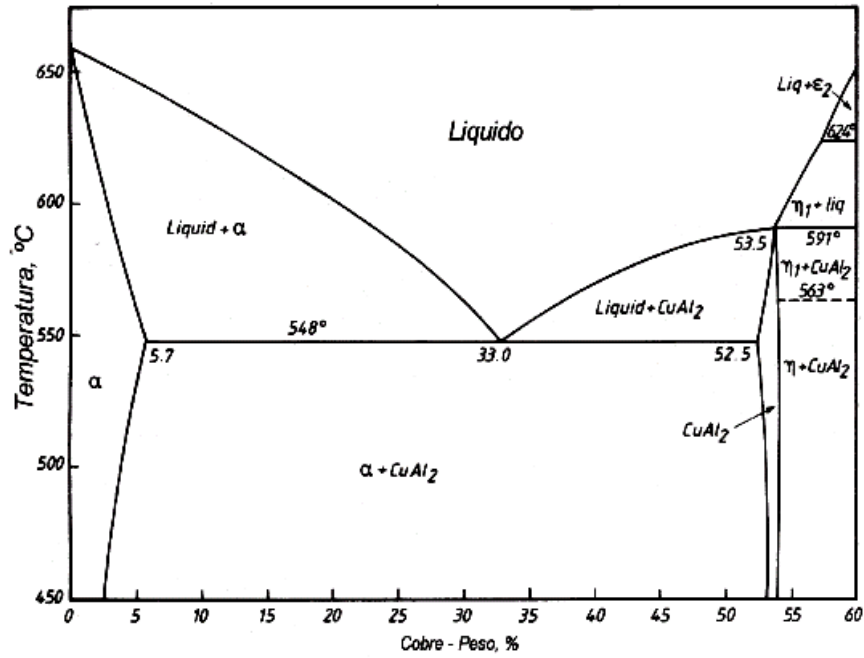

Figura 7.- Diagrama de fases Pb-Sn

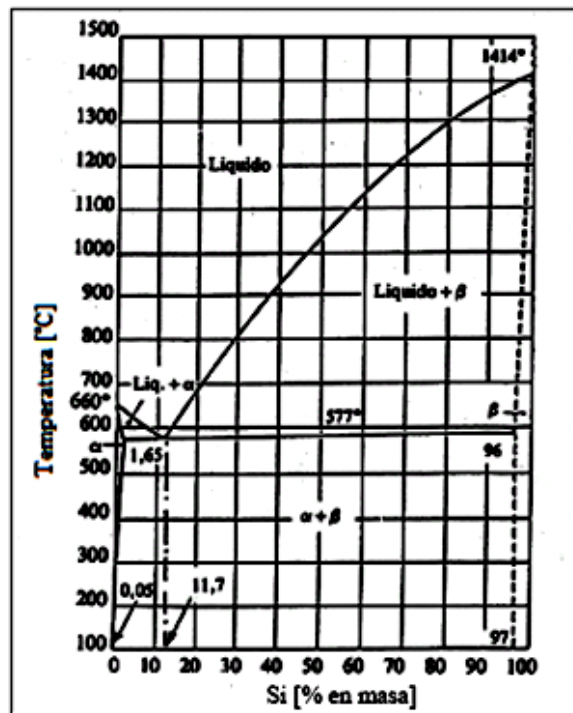

Figura 8.- Diagrama de fases magnesio-plomo

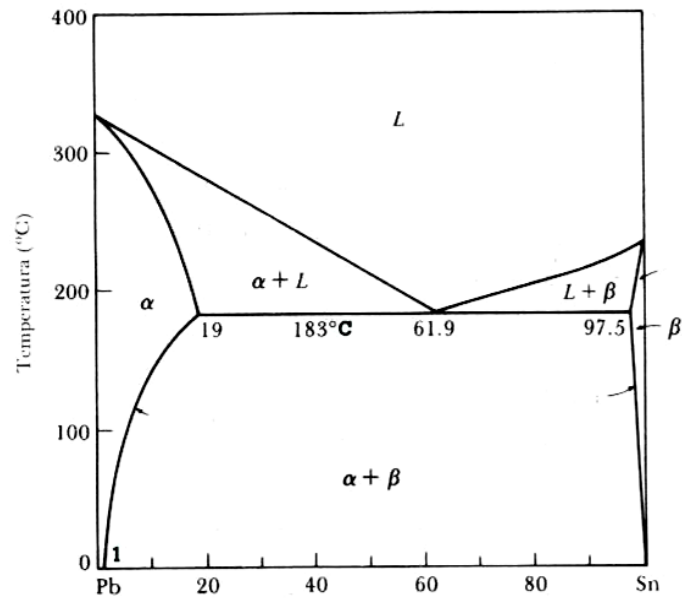

Figura 9. Ensayo de templabilidad Jominy

DIAGRAMAS TTT PARA ACEROS CON DIFERENTE CONTENIDO DE CARBONO

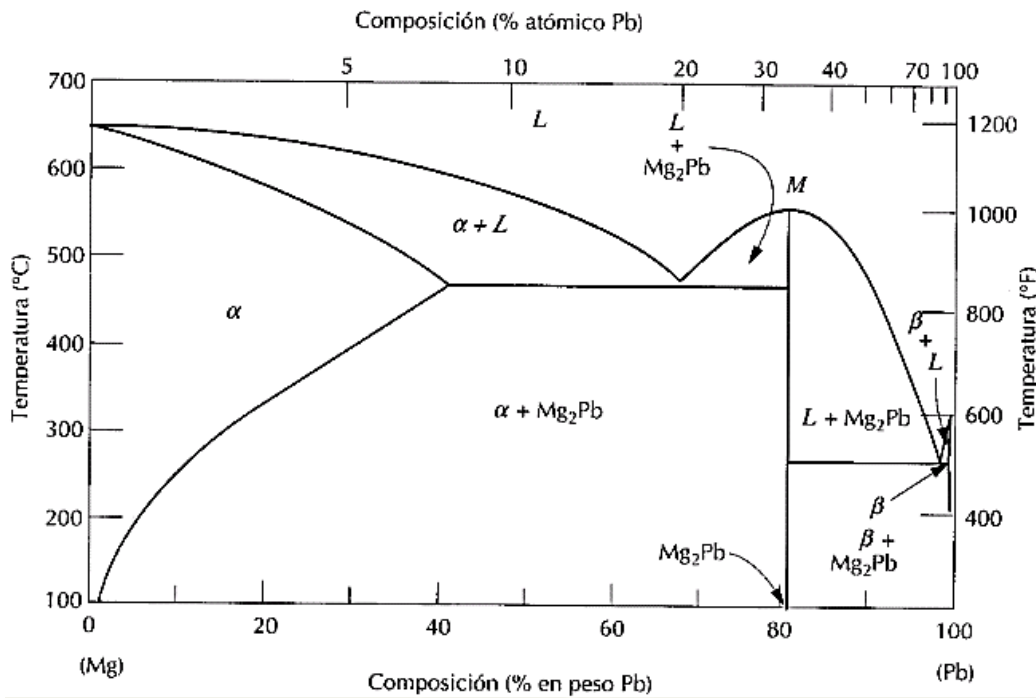

Figura 10.- Acero con 1.13% de C

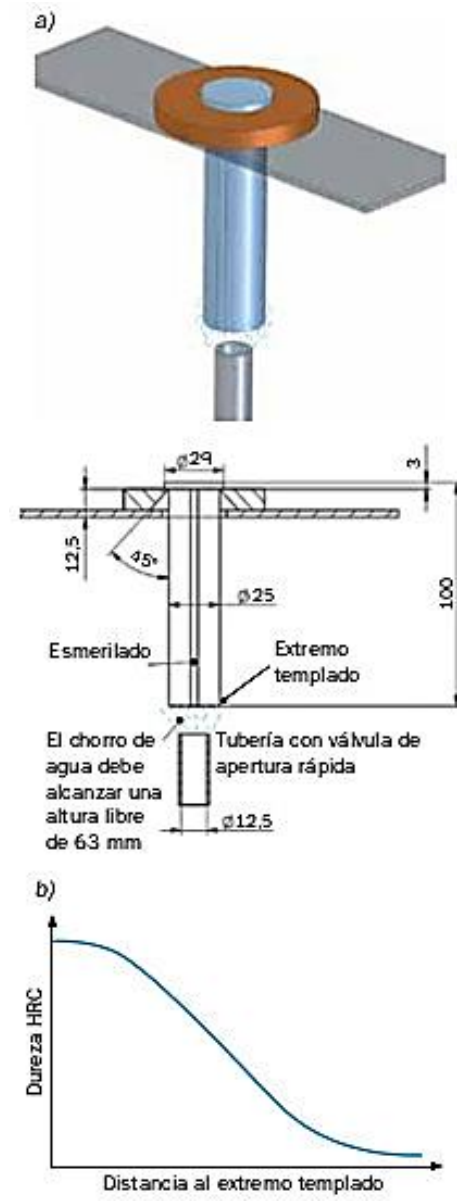

Figura 11.- Acero con 0.8 % de C.

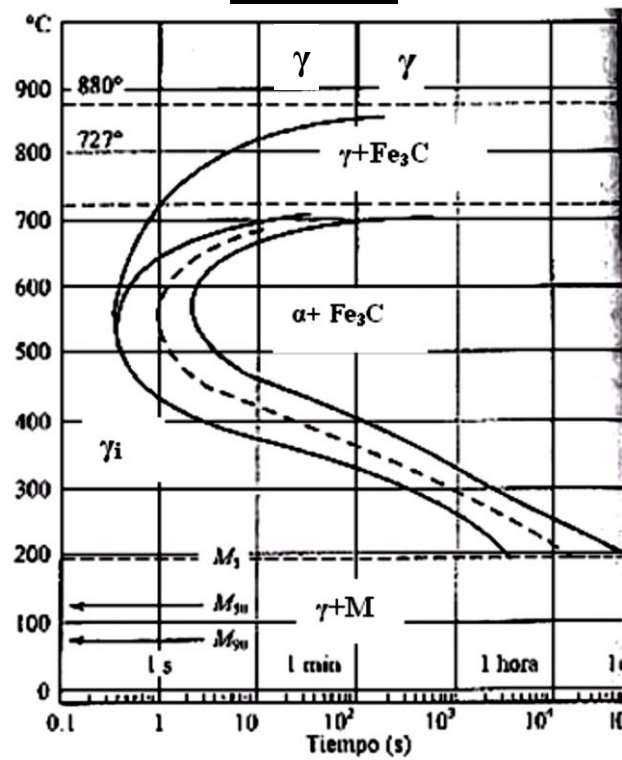

Figura 12.- Acero con 0.55 % de C.

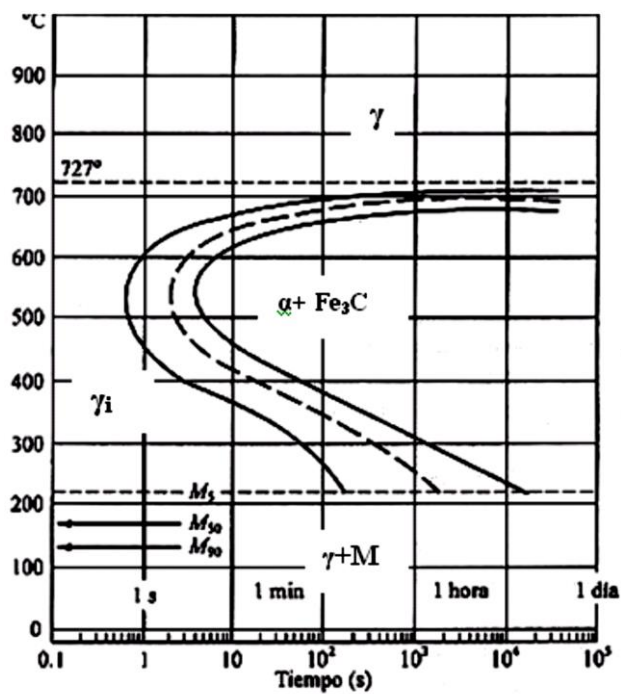

Figura 13. Temperaturas M_s y M_f en función del contenido de carbono

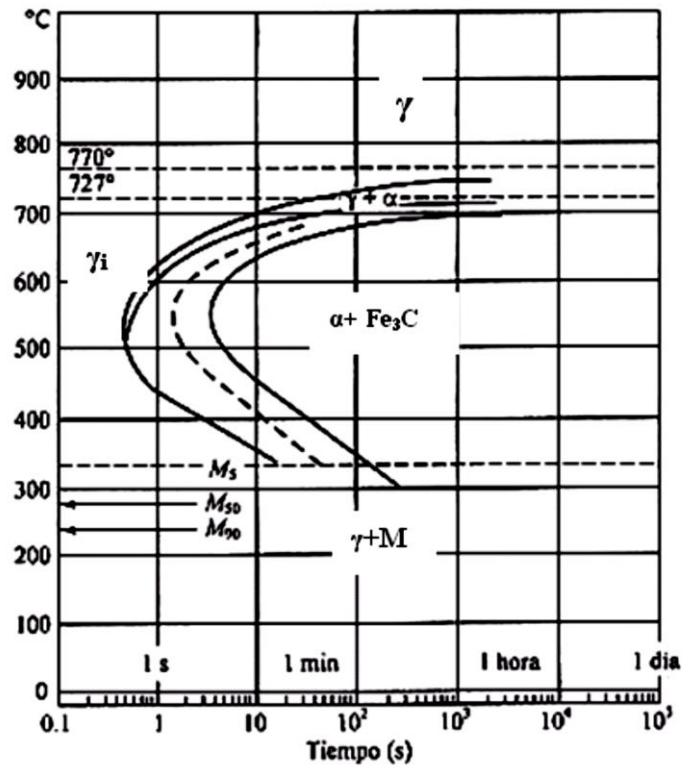

Figura 14. Variación de la cantidad de la austenita retenida en función del contenido de carbono

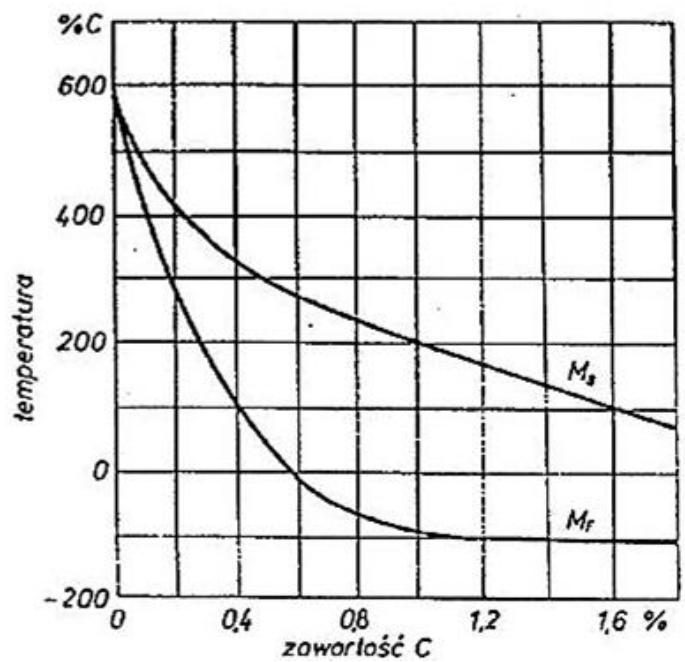

Figura 15.- Relaciones entre las tasas de enfriamiento en barras redondas y en localizaciones Jominy

- Curva 1.- Agua quieta
- Curva 2.- Aceite ligeramente agitado
- Curva 3.- Aceite quieto
- Curva 4.- Sales fundidas.

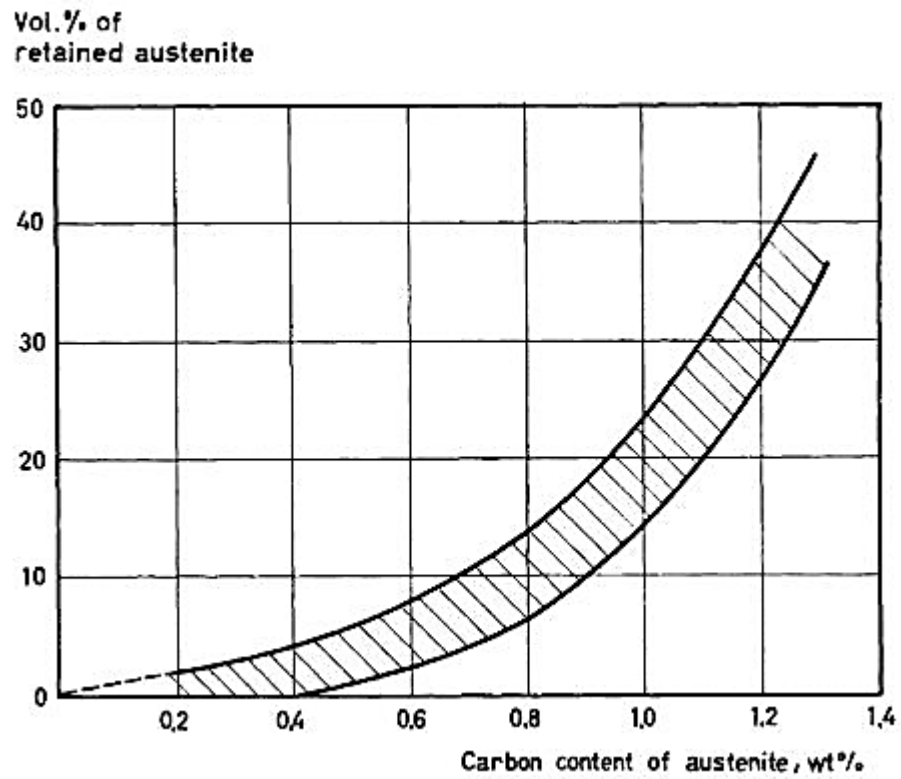

Figura 16.- Curvas de templabilidad para distintos aceros

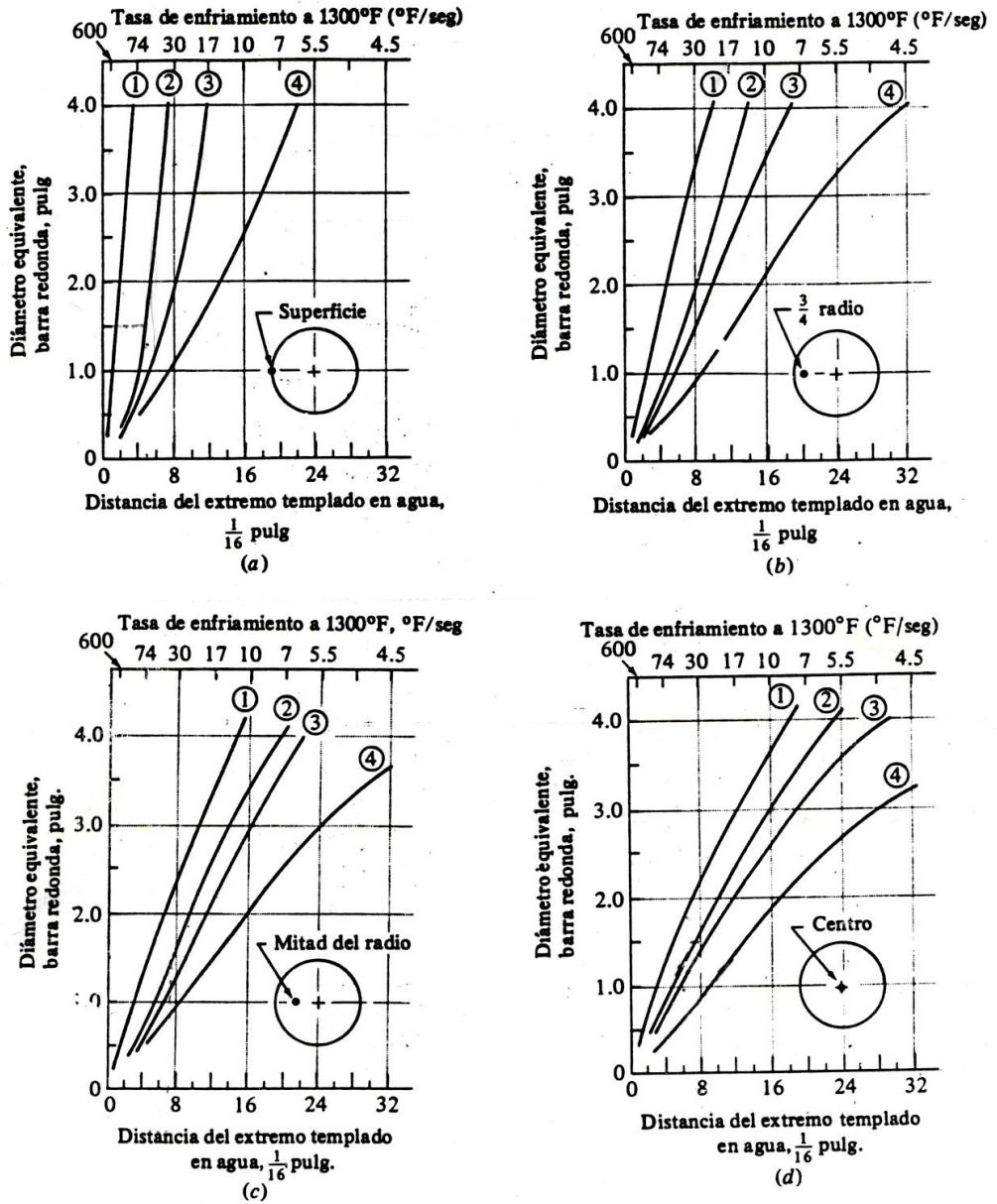

Figura 17. Diagrama de fases Fe-Cr

SERIE ELECTROQUÍMICA

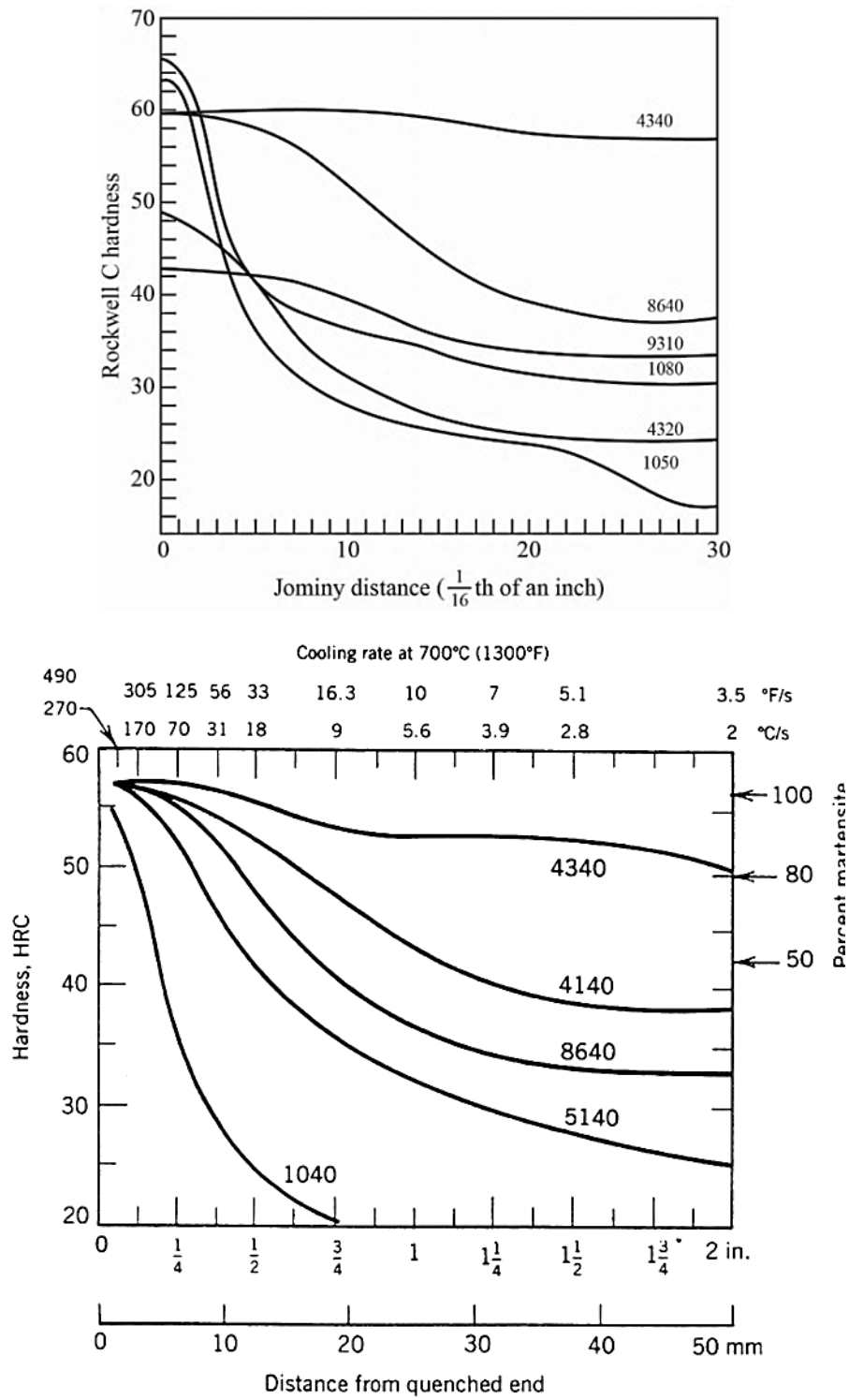
Reacción de reducción	Potencial E_0	
$\text{Au}^{3+} + 3\text{e}^- \rightarrow \text{Au}$	+1.50	↑ Catódica
$\text{O}_2 + 4\text{H}^+ + 4\text{e}^- \rightarrow 2\text{H}_2\text{O}$	+1.23	
$\text{Pt}^{4+} + 4\text{e}^- \rightarrow \text{Pt}$	+1.20	
$\text{Pd}^{2+} + 2\text{e}^- \rightarrow \text{Pd}$	+0.99	
$\text{Ag}^+ + \text{e}^- \rightarrow \text{Ag}$	+0.80	
$\text{Hg}_2^{2+} + 2\text{e}^- \rightarrow 2\text{Hg}$	+0.79	
$\text{Fe}^{3+} + \text{e}^- \rightarrow \text{Fe}^{2+}$	+0.77	
$\text{O}_2 + \text{H}_2\text{O} + 4\text{e}^- \rightarrow 4(\text{OH})^-$	+0.40	
$\text{Cu}^{2+} + 2\text{e}^- \rightarrow \text{Cu}$	+0.34	
$2\text{H}^+ + 2\text{e}^- \rightarrow \text{H}_2$	0.00	
$\text{Pb}^{2+} + 2\text{e}^- \rightarrow \text{Pb}$	-0.13	
$\text{Sn}^{2+} + 2\text{e}^- \rightarrow \text{Sn}$	-0.14	
$\text{Ni}^{2+} + 2\text{e}^- \rightarrow \text{Ni}$	-0.25	
$\text{Fe}^{2+} + 2\text{e}^- \rightarrow \text{Fe}$	-0.44	
$\text{Cr}^{2+} + 2\text{e}^- \rightarrow \text{Cr}$	-0.56	
$\text{Zn}^{2+} + 2\text{e}^- \rightarrow \text{Zn}$	-0.76	
$\text{Mn}^{2+} + 2\text{e}^- \rightarrow \text{Mn}$	-1.63	
$\text{Ti}^{2+} + 2\text{e}^- \rightarrow \text{Ti}$	-1.63	
$\text{Al}^{3+} + 3\text{e}^- \rightarrow \text{Al}$	-1.66	
$\text{Be}^{2+} + 2\text{e}^- \rightarrow \text{Be}$	-1.85	
$\text{Mg}^{2+} + 2\text{e}^- \rightarrow \text{Mg}$	-2.36	
$\text{Na}^+ + \text{e}^- \rightarrow \text{Na}$	-2.71	
$\text{Ca}^+ + \text{e}^- \rightarrow \text{Ca}$	-2.76	
$\text{K}^+ + \text{e}^- \rightarrow \text{K}$	-2.92	
$\text{Rb}^+ + \text{e}^- \rightarrow \text{Rb}$	-2.93	Anódica ↓
$\text{Li}^+ + \text{e}^- \rightarrow \text{Li}$	-2.96	

SERIE GALVÁNICA

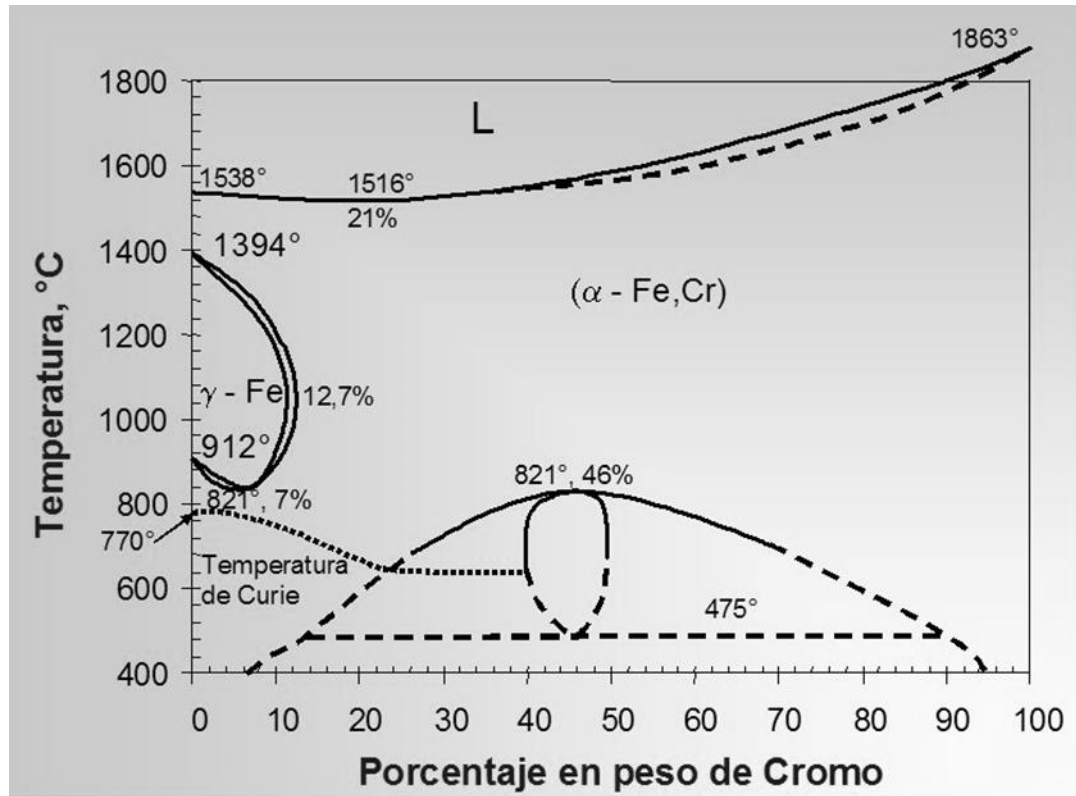
(EN AGUA DE MAR)

Noble o Catódico	↑	Platino
		Oro
		Grafito
		Titania
		Plata
		Chlorimet 3 (62Ni, 18Cr, 18Mo)
		Hastelloy C (62Ni, 17Cr, 15Mo)
		Acero inoxidable al Mo 18-8 (pasivo)
		Acero inoxidable 18-8 (pasivo)
		Acero inoxidable al cromo, 11-30%Cr (pasivo)
		Inconel (pasivo) (80Ni, 13Cr, 7Fe)
		Níquel (pasivo)
		Monel (70Ni, 30Cu)
		Cuproníquel (60-90Cu, 40-10Ni)
		Bronces (Cu-Sn)
	Cobre	
	Latones (Cu-Zn)	
	Chlorimet 2 (66Ni, 32Mo, 1Fe)	
	Hastelloy B (60Ni, 30Mo, 6Fe, 1Mg)	
	Inconel (activo)	
	Níquel (activo)	
	Estañó	
	Plomo	
	Acero inoxidable al Mo 18-8 (activo)	
	Acero inoxidable 18-8 (activo)	
	Acero inoxidable al cromo, 13%Cr (activo)	
	Fundición de hierro	
	Acero o hierro	
	Aluminio 2024 (4.5Cu, 1.5Mg, 0.6Mn)	
Activo o Anódico	●	Cadmio
		Aluminio comercialmente puro (1100)
		Zinc
	↓	Magnesio y sus aleaciones

